

Appendix V Soil Layer Profile of 27 Sections in Noshiro City

The soil layer profiles along 27 section lines, shown in Figure 2-10, in Noshiro City were estimated as follows ;

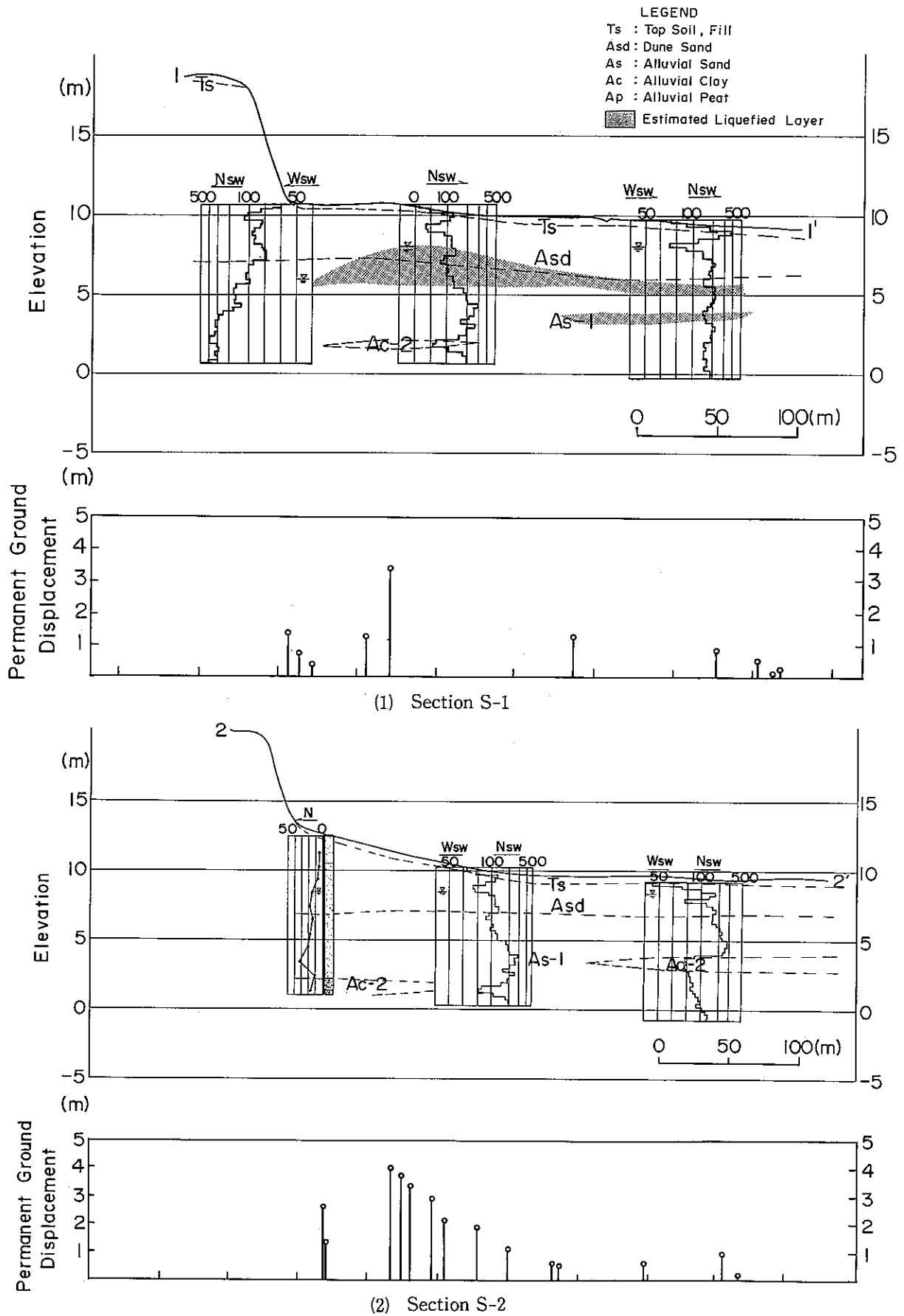

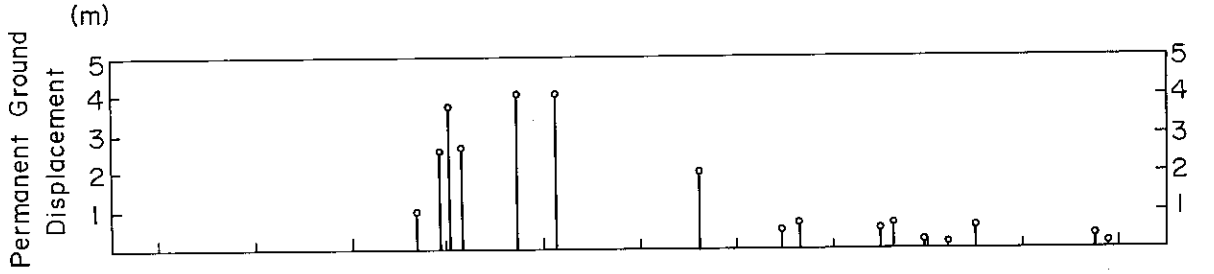
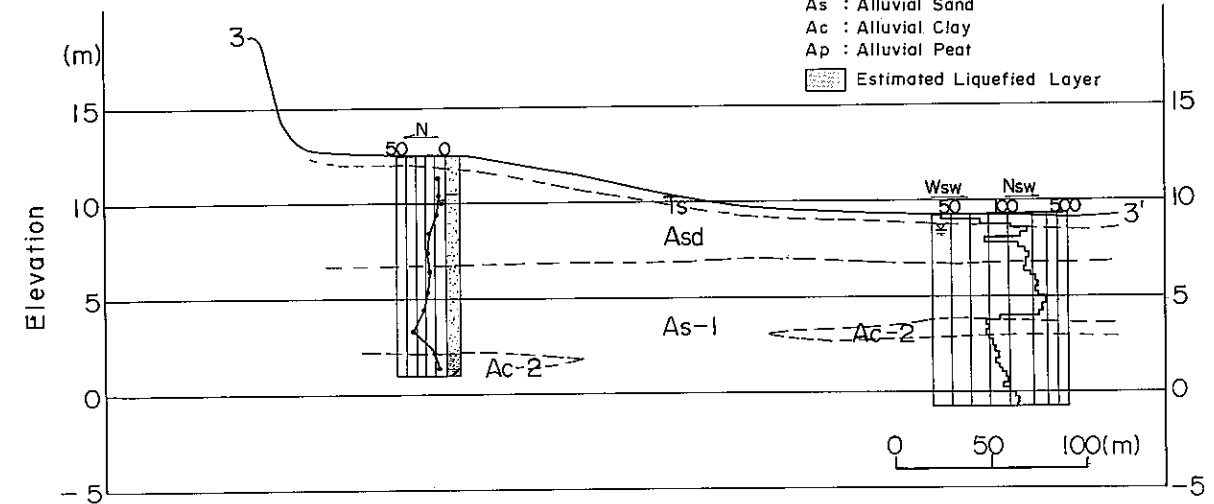

Fig. V-1 Soil layer profile in Noshiro City

LEGEND

- Ts : Top Soil, Fill
- Asd : Dune Sand
- As : Alluvial Sand
- Ac : Alluvial Clay
- Ap : Alluvial Peat

 Estimated Liquefied Layer



(3) Section S-3

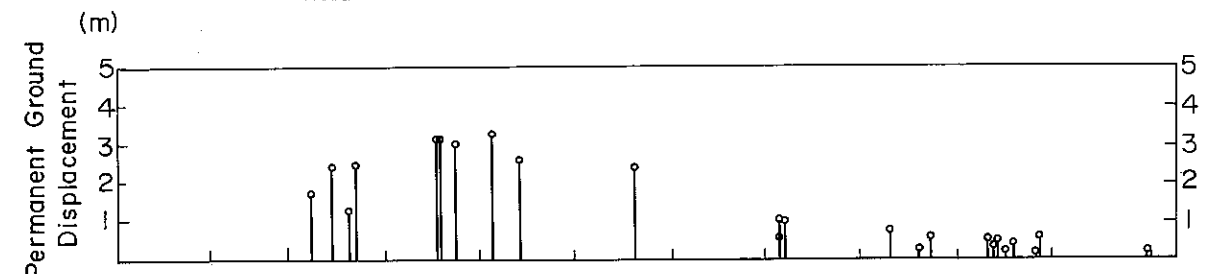
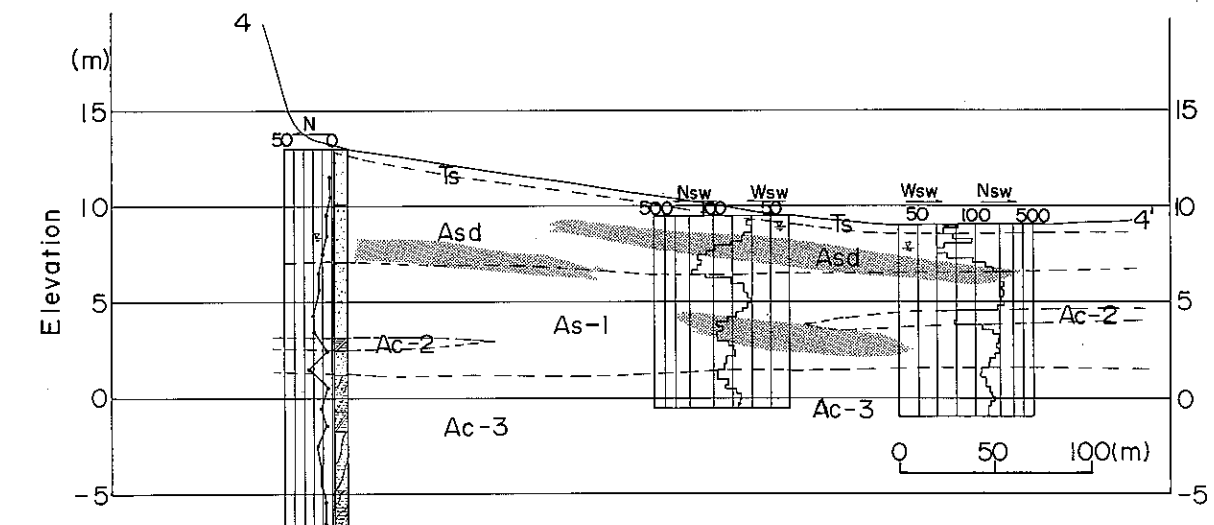

(4) Section S-4

Fig. V-1 Soil layer profile in Noshiro City

LEGEND

- Ts : Top Soil, Fill
- Asd : Dune Sand
- As : Alluvial Sand
- Ac : Alluvial Clay
- Ap : Alluvial Peat
-  Estimated Liquefied Layer

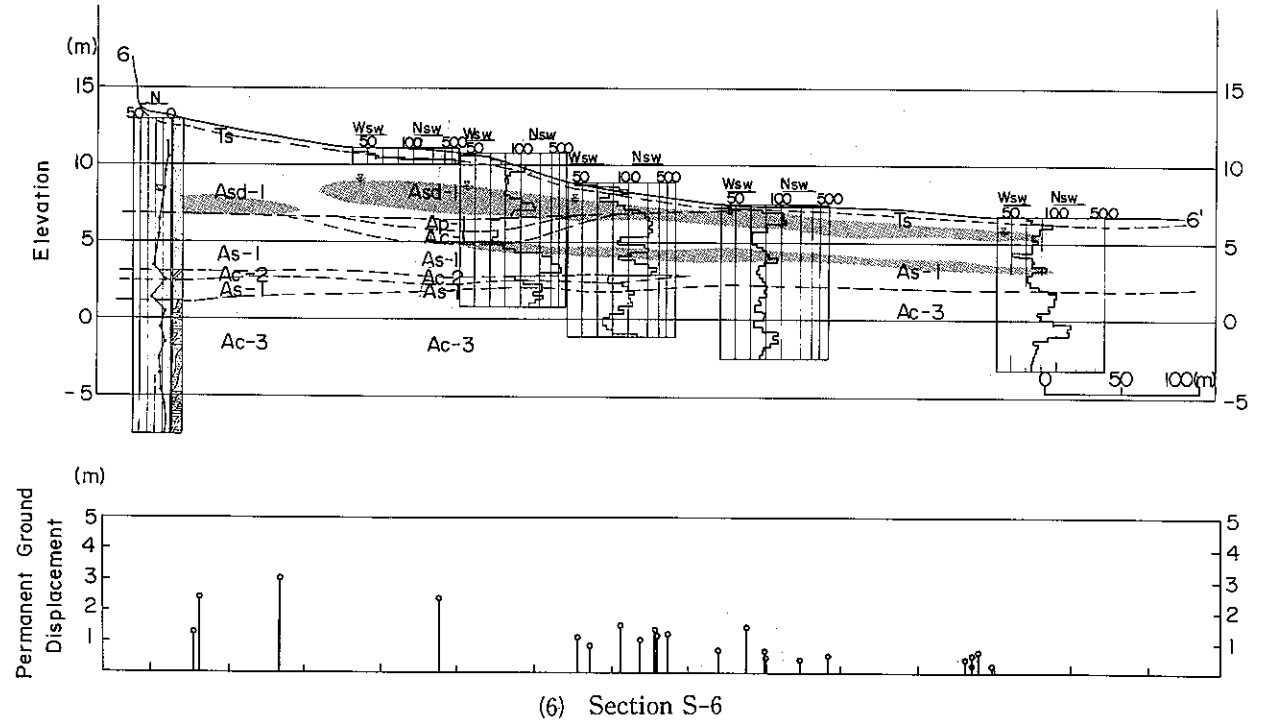
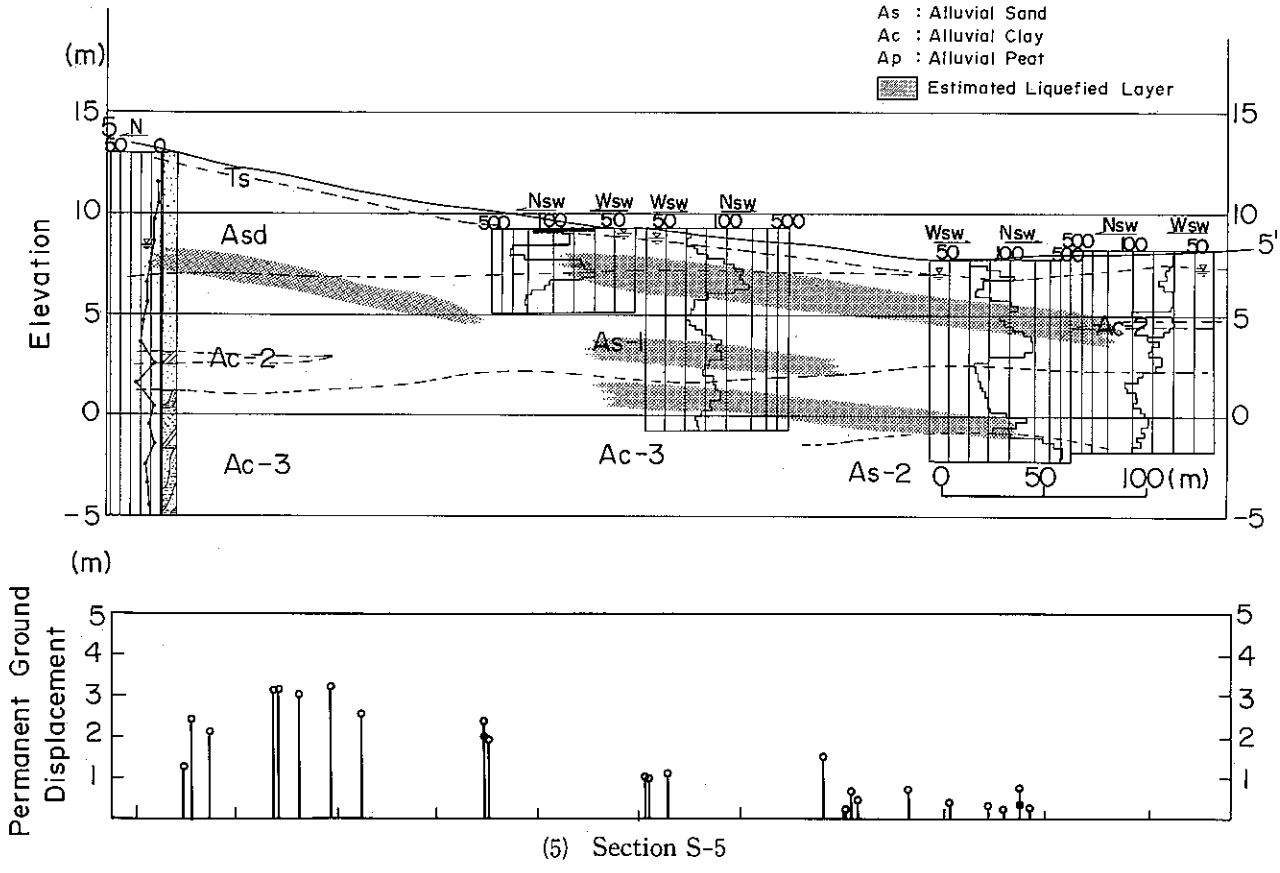

Fig. V-1 Soil layer profile in Noshiro City

LEGEND
 Ts : Top Soil, Fill
 Asd : Dune Sand
 As : Alluvial Sand
 Ac : Alluvial Clay
 Ap : Alluvial Peat
 [Hatched Box] Estimated Liquefied Layer

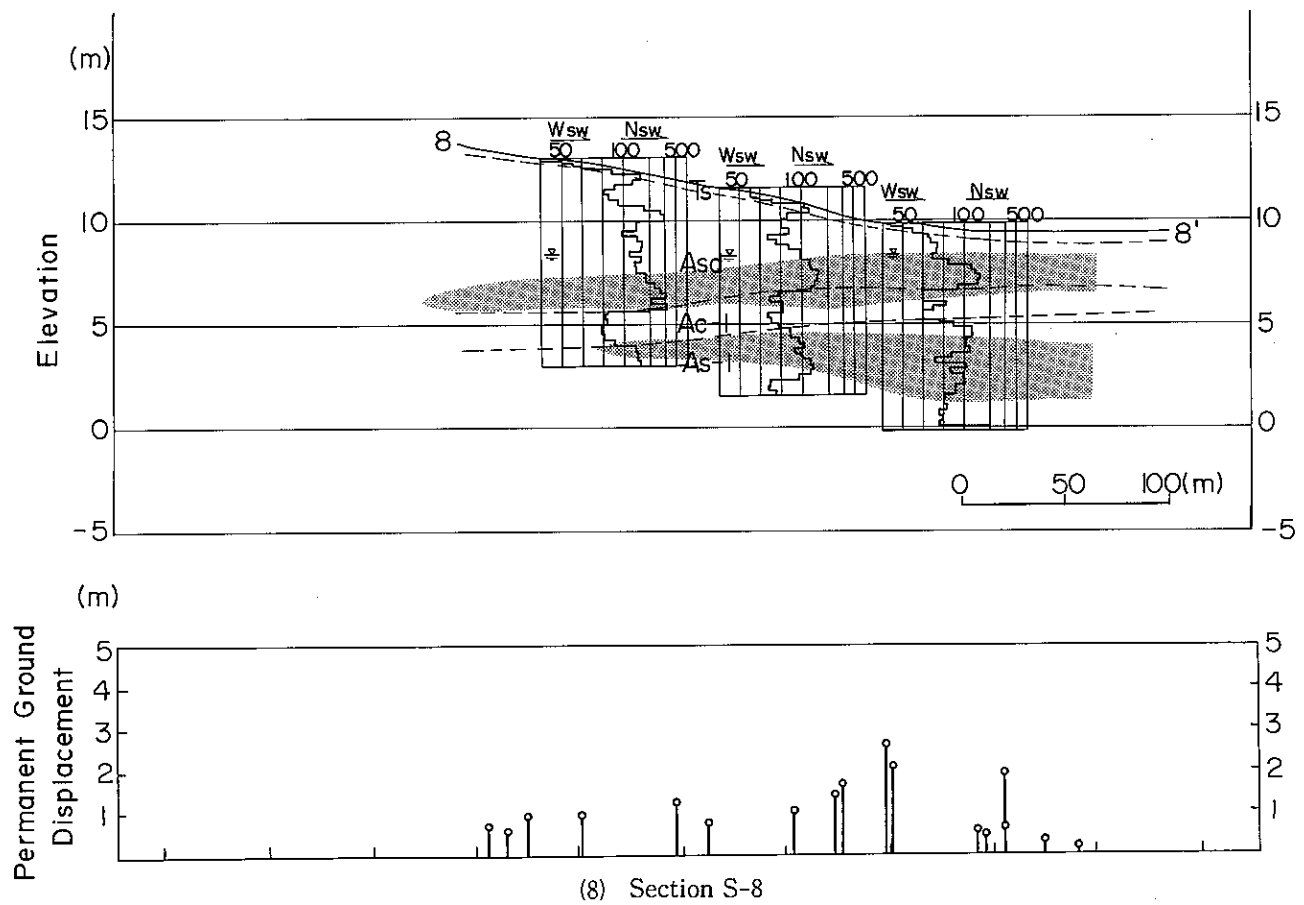
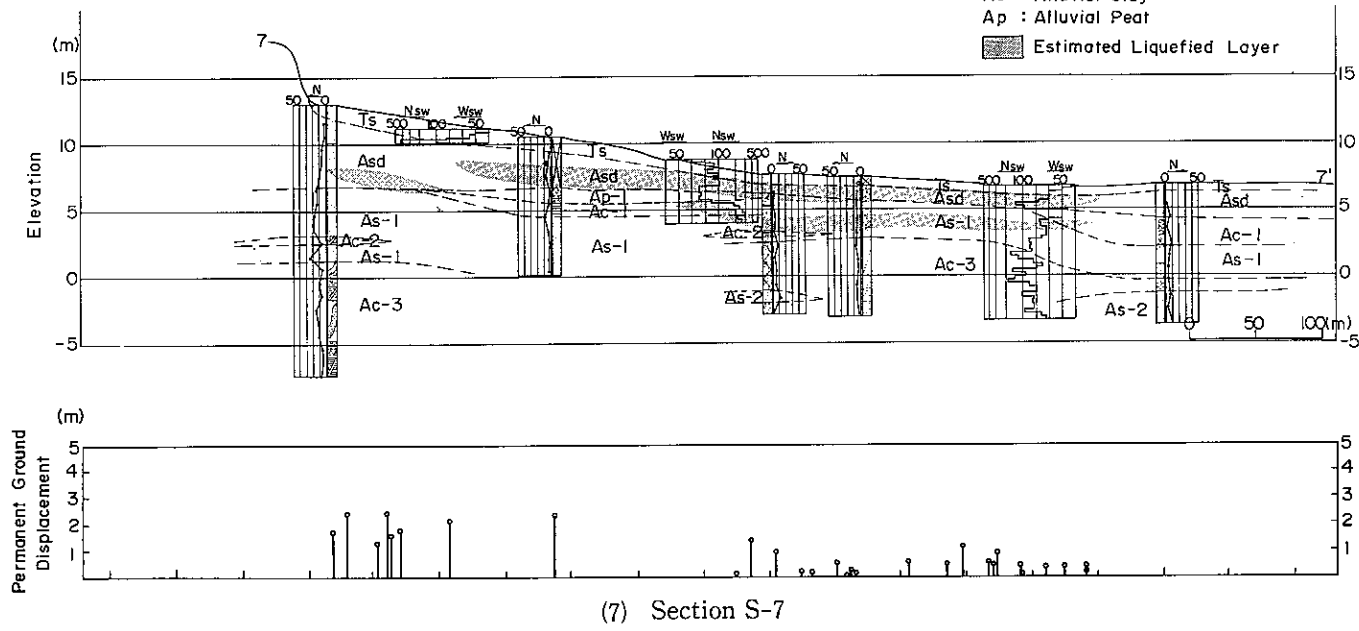

Fig. V-1 Soil layer profile in Noshiro City

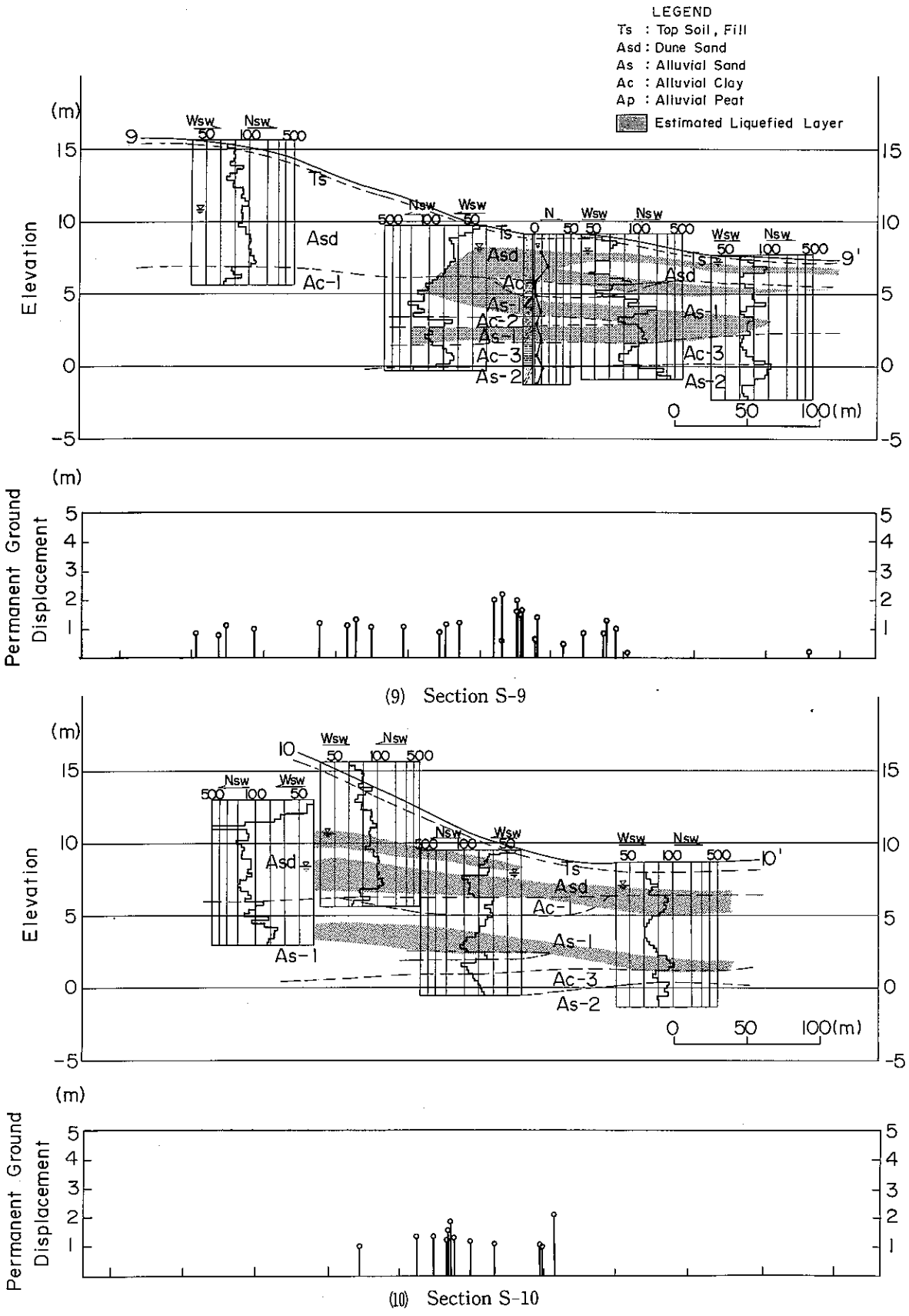

Fig. V-1 Soil layer profile in Noshiro City

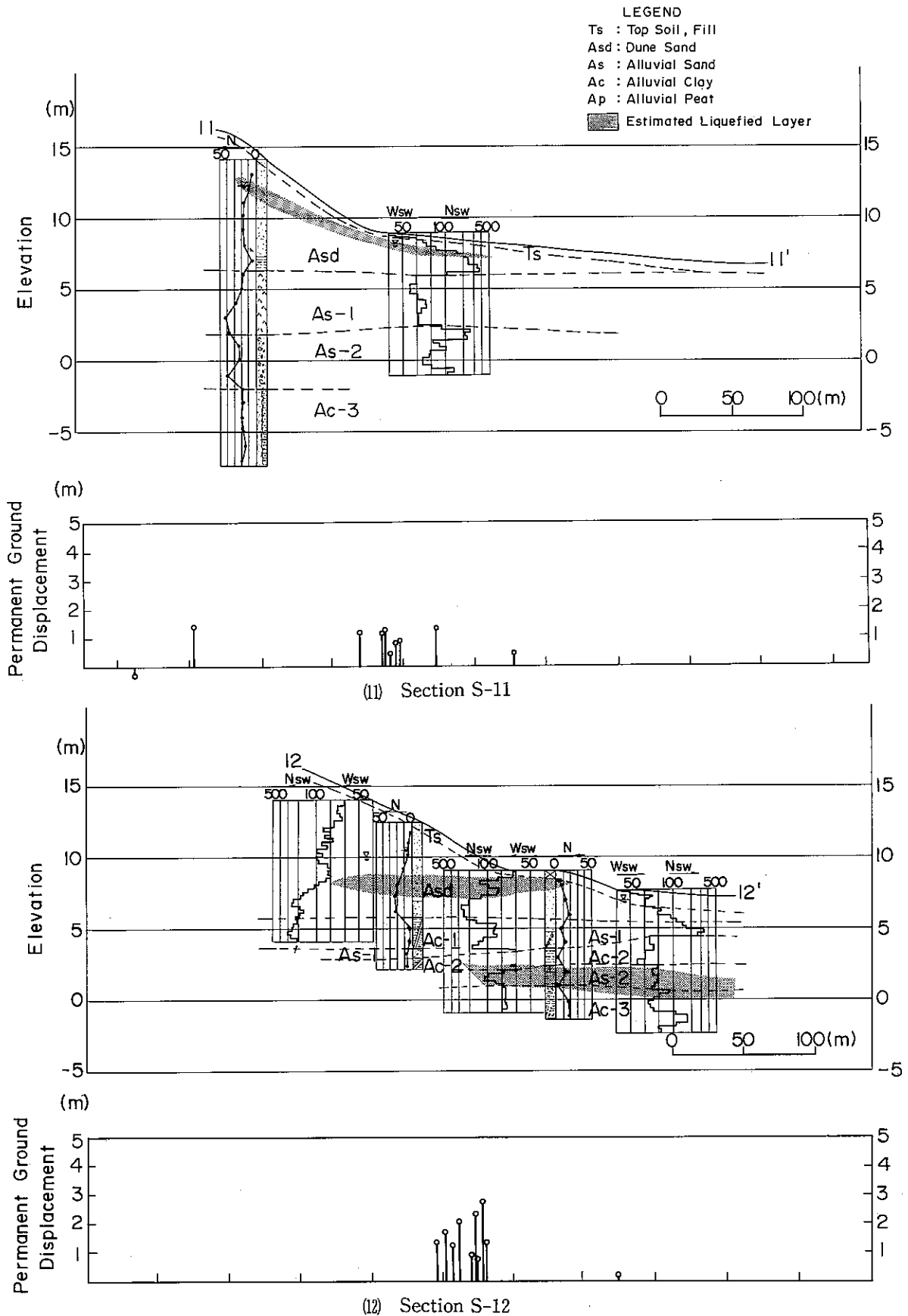

Fig. V-1 Soil layer profile in Noshiro City

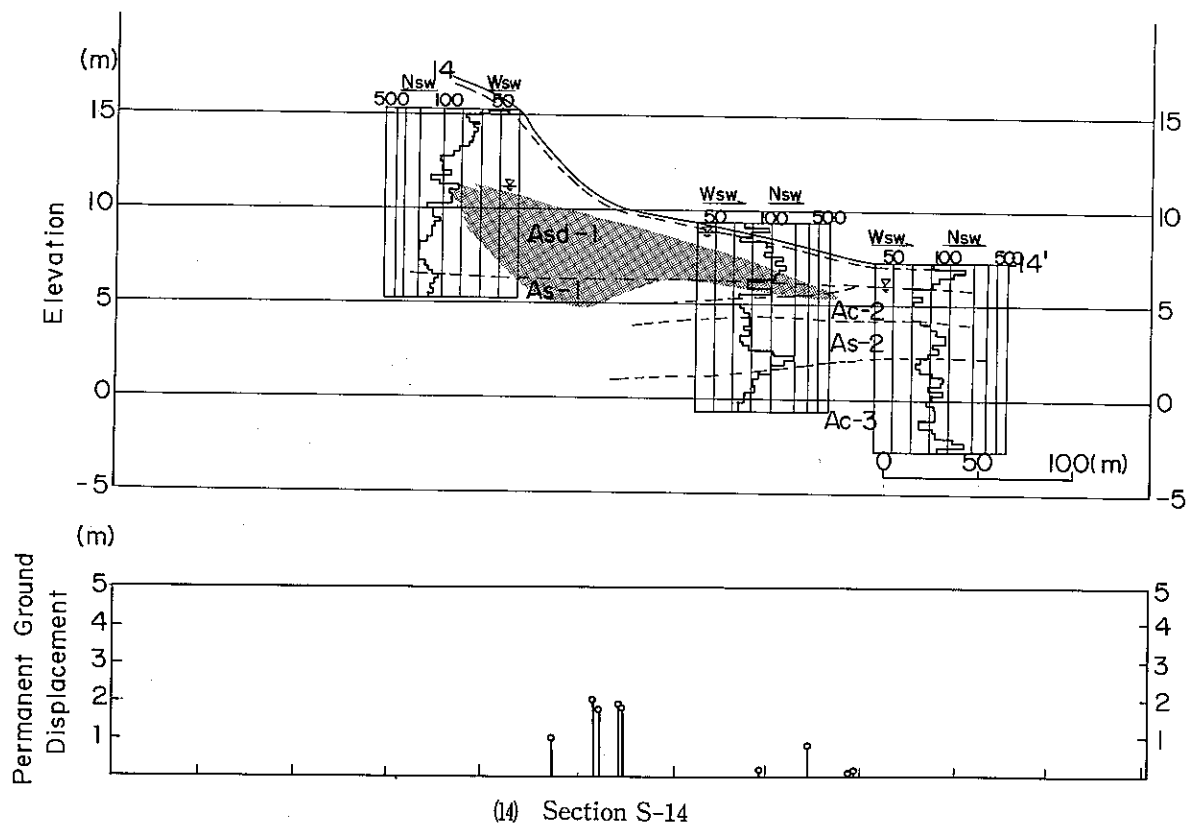
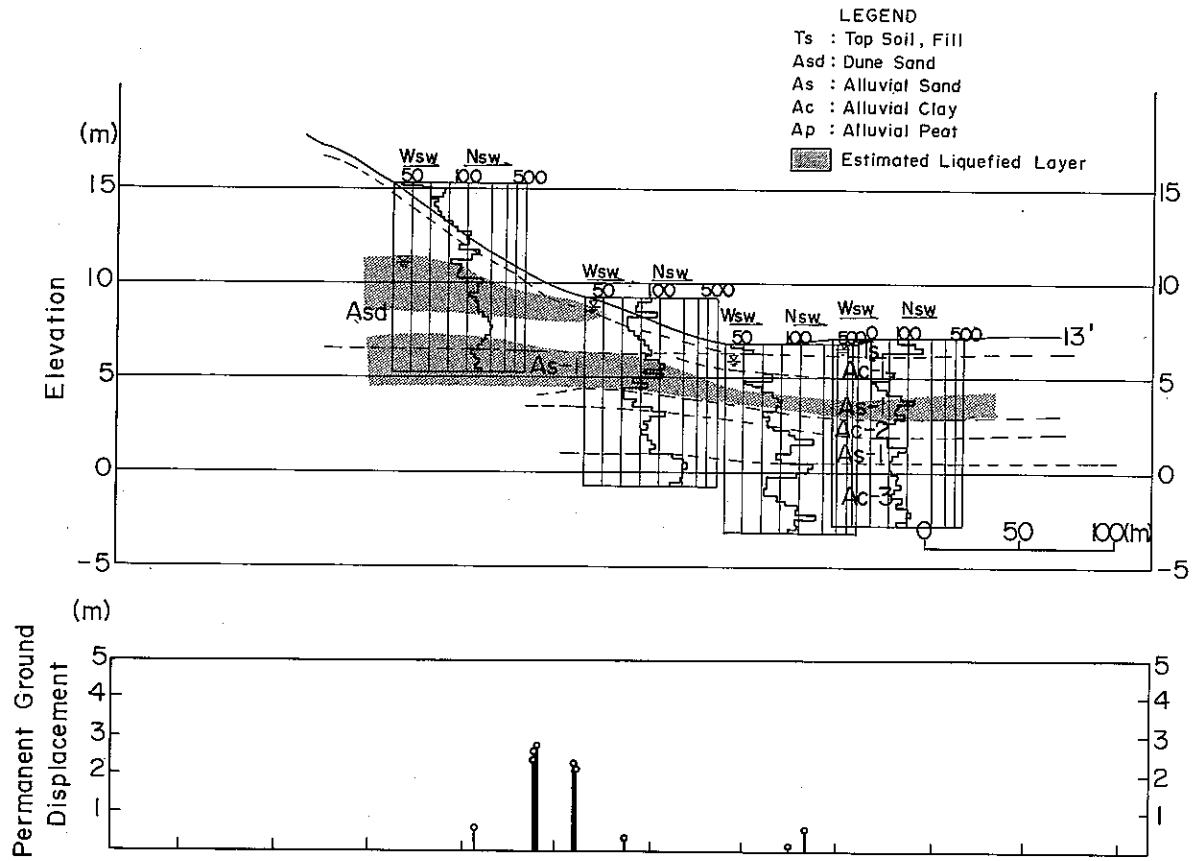

Fig. V-1 Soil layer profile in Noshiro City

LEGEND
 Ts : Top Soil, Fill
 Asd : Dune Sand
 As : Alluvial Sand
 Ac : Alluvial Clay
 Ap : Alluvial Peat
 [Hatched Box] Estimated Liquefied Layer

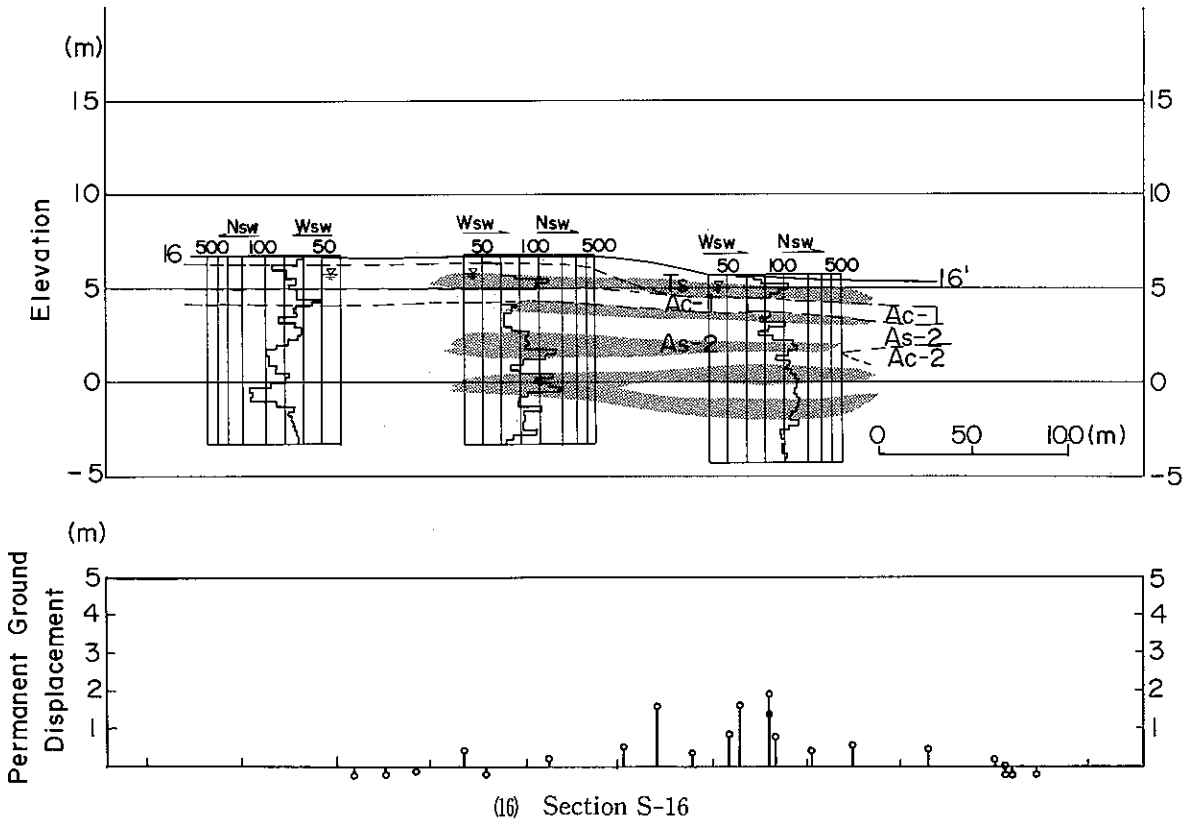
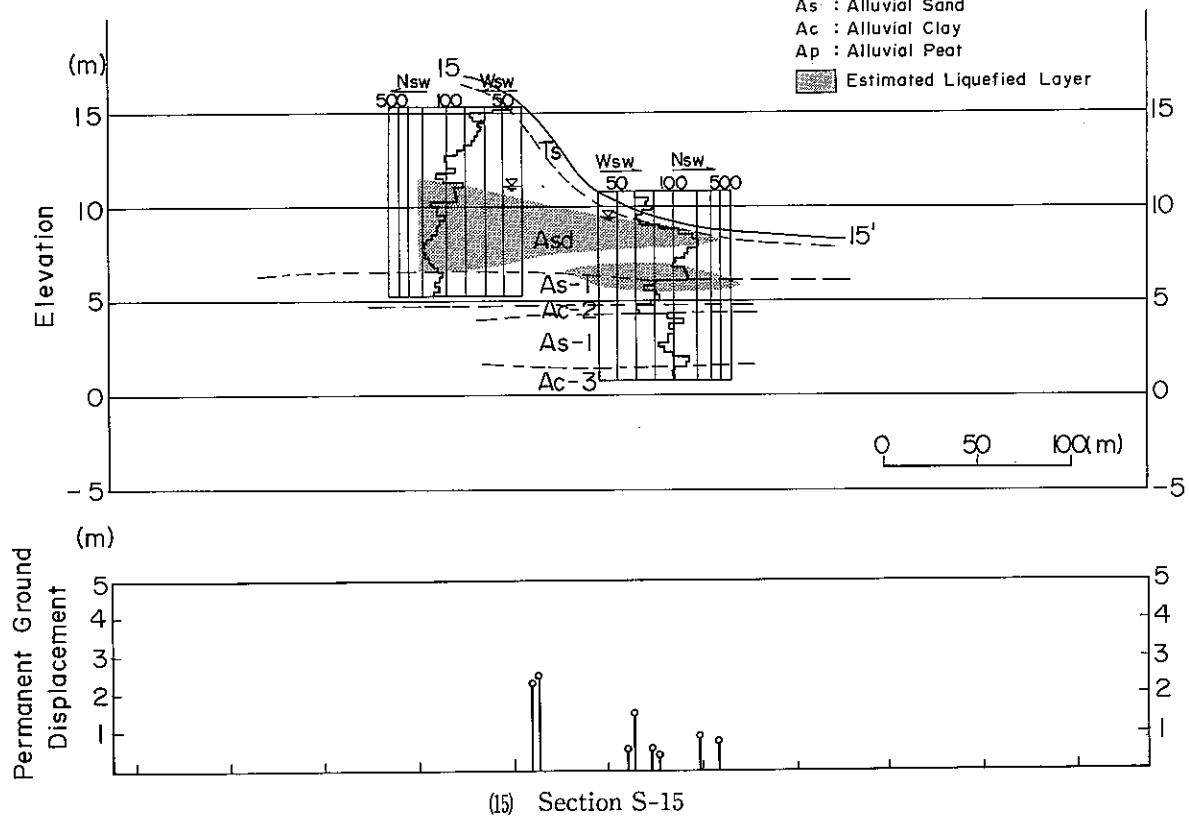

Fig. V-1 Soil layer profile in Noshiro City

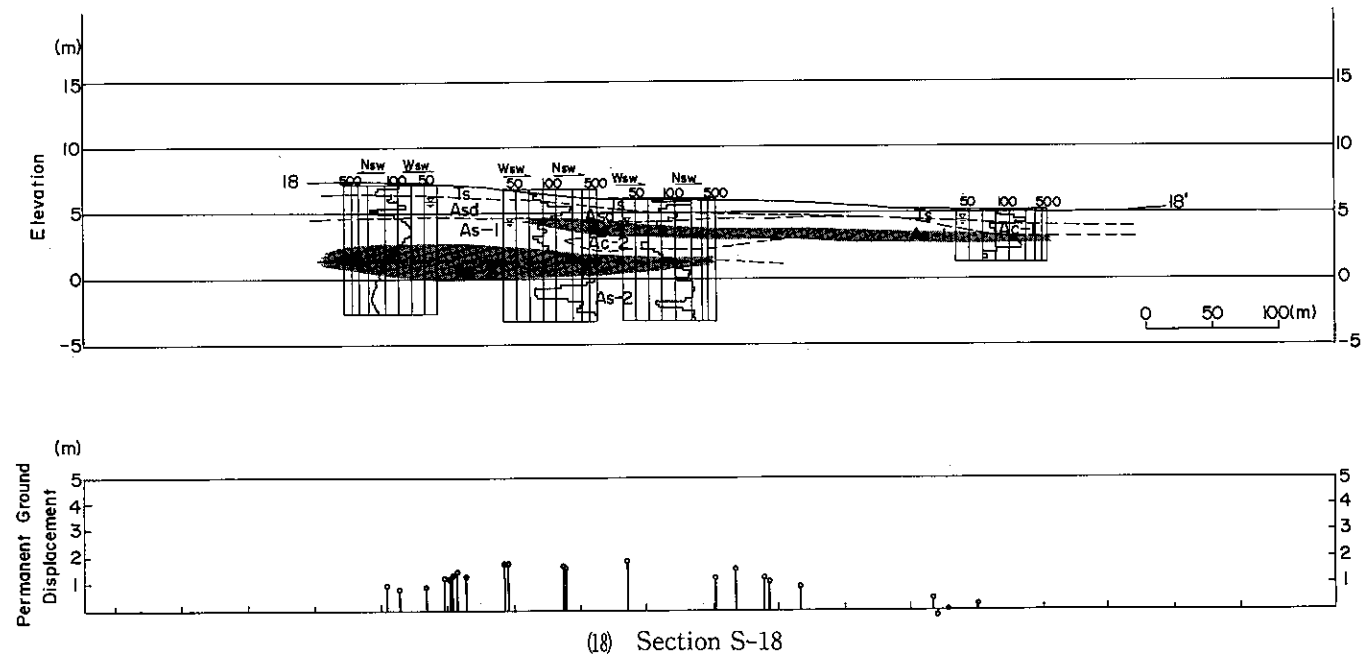
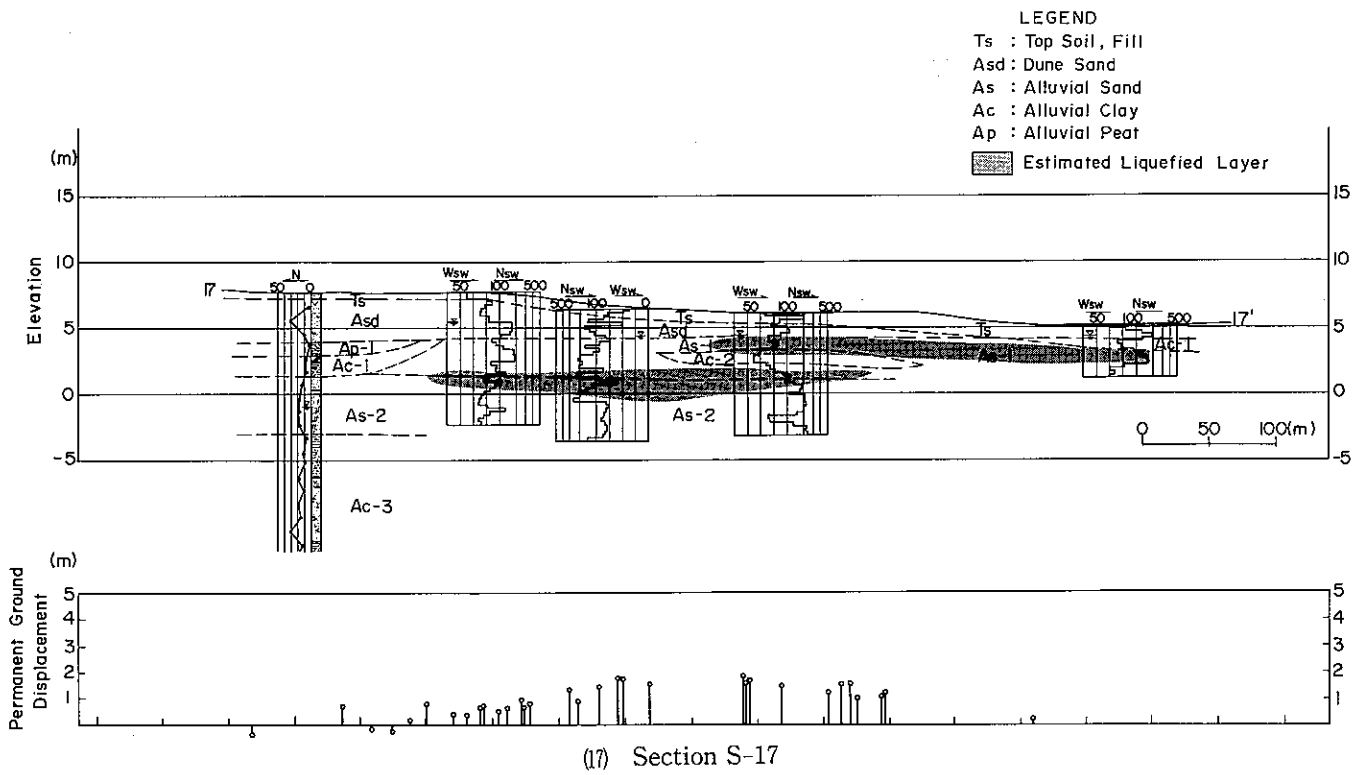

Fig. V-1 Soil layer profile in Noshiro City

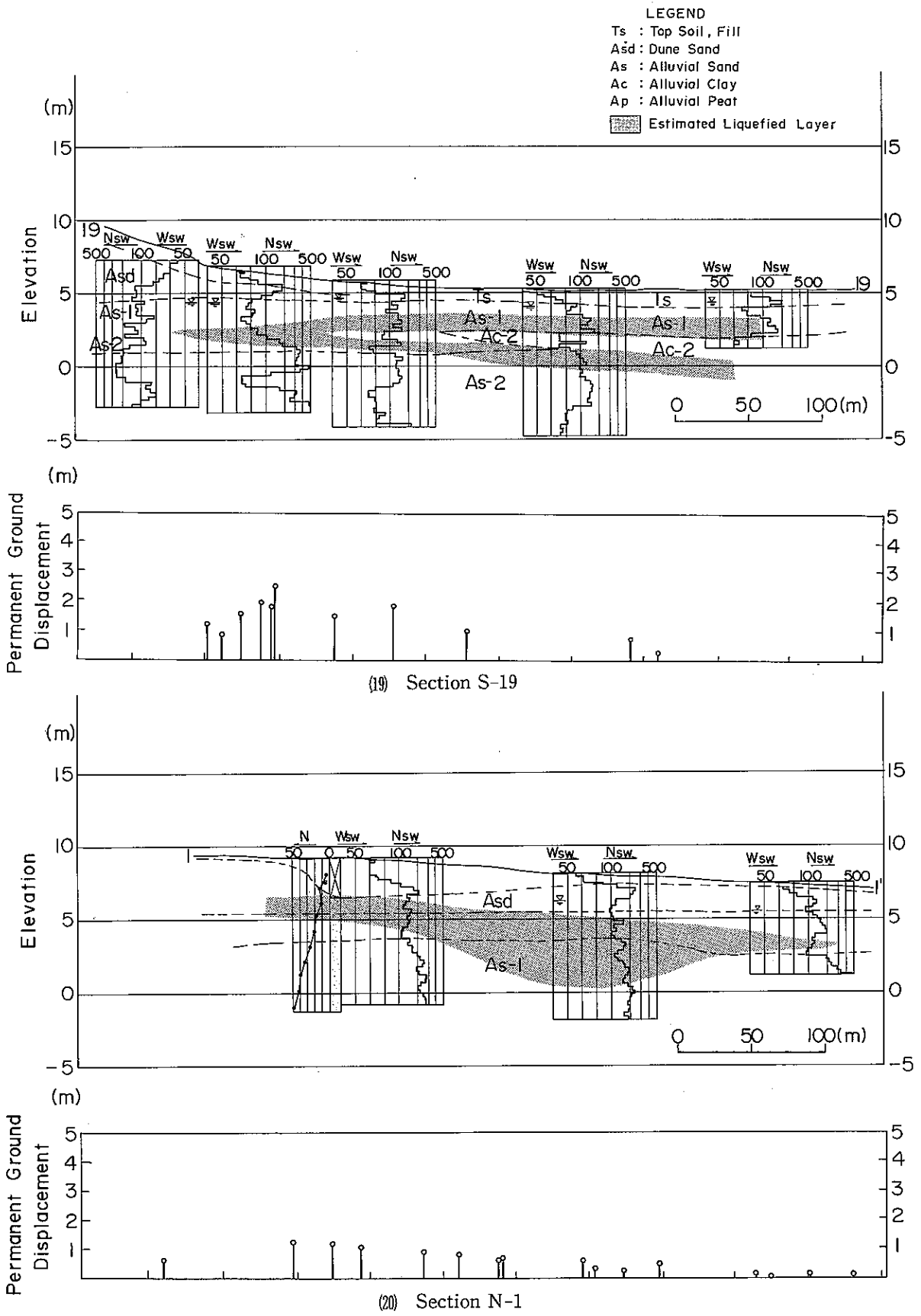

Fig. V-1 Soil layer profile in Noshiro City

LEGEND

Ts : Top Soil, Fill

Asd : Dune Sand

As : Alluvial Sand

Ac : Alluvial Clay

Ap : Alluvial Peat

Estimated Liquefied Layer

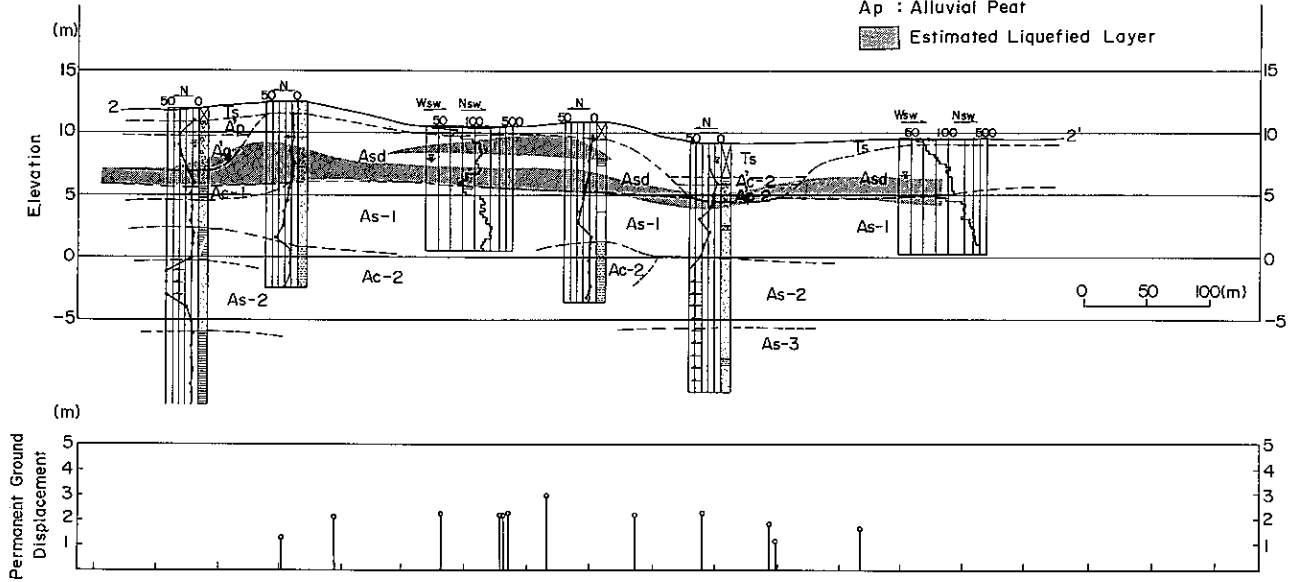

(1) Section N-2

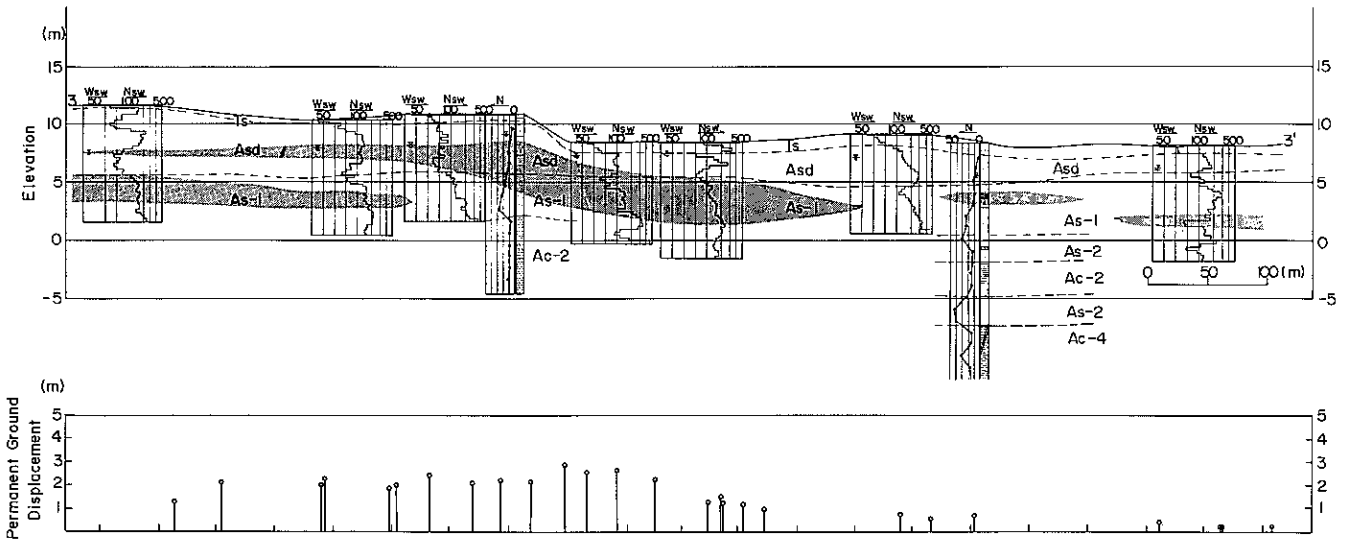

(2) Section N-3

Fig. V-1 Soil layer profile in Noshiro City

- LEGEND
- Ts : Top Soil, Fill
 - Asd : Dune Sand
 - As : Alluvial Sand
 - Ac : Alluvial Clay
 - Ap : Alluvial Peat

Estimated Liquefied Layer

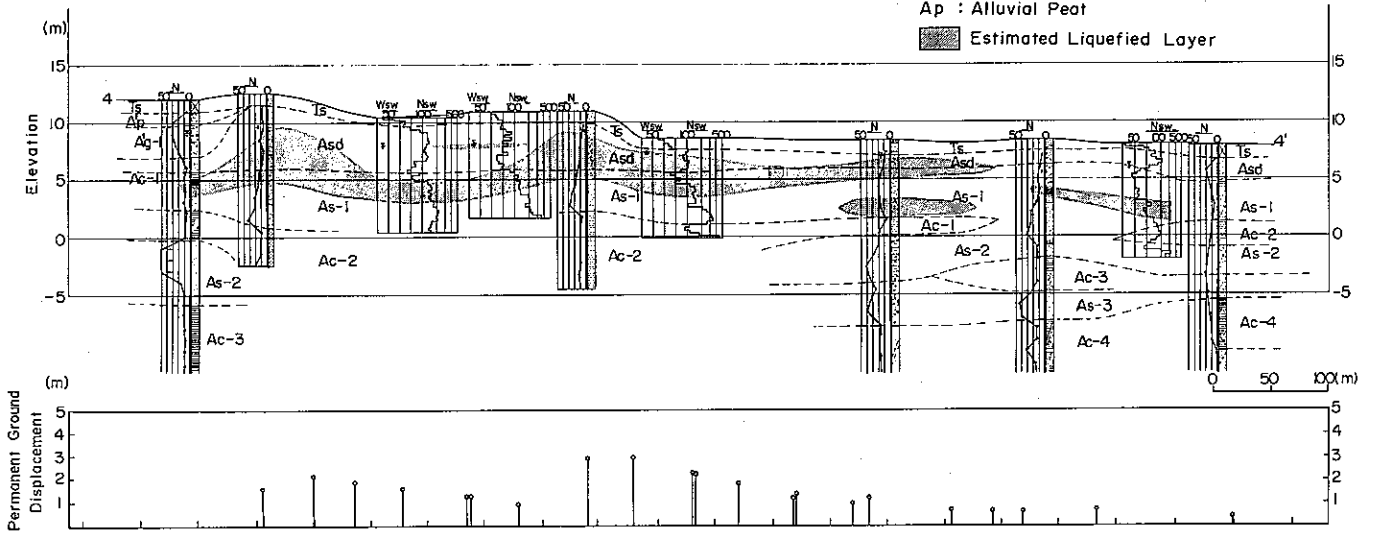

(23) Section N-4

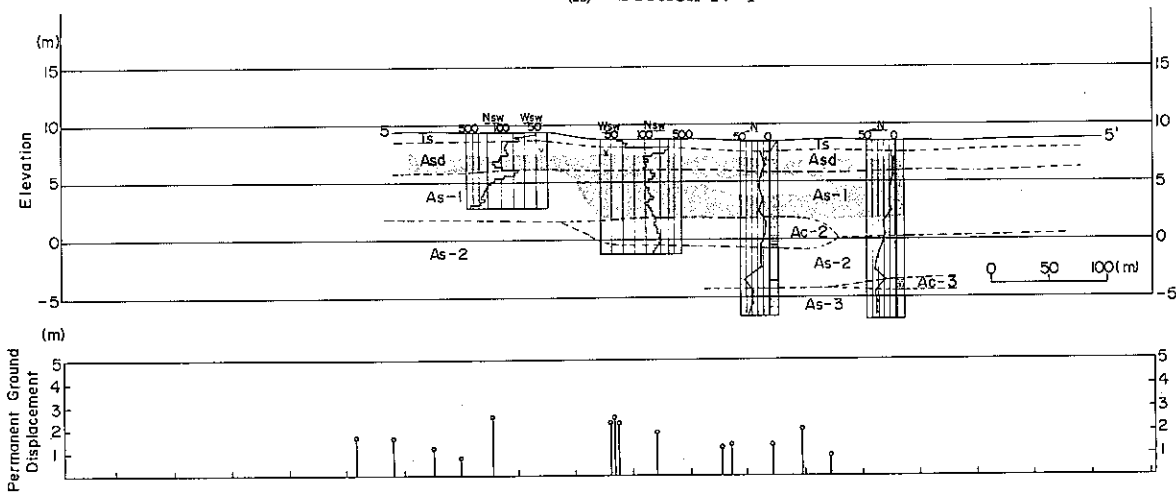

(24) Section N-5

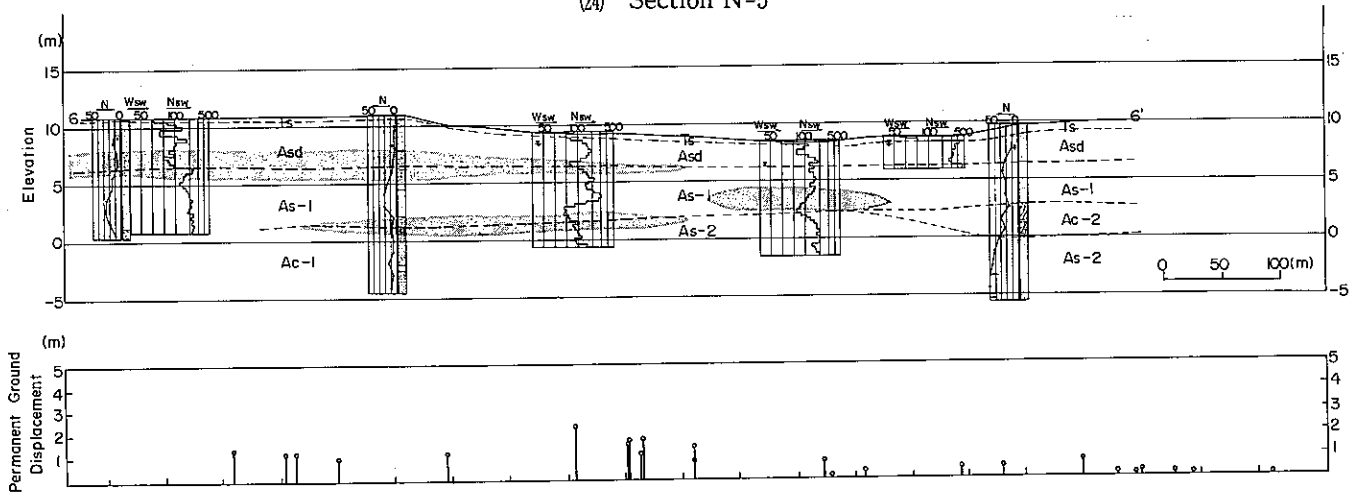

(25) Section N-6

Fig. V-1 Soil layer profile in Noshiro City

- LEGEND
 Ts : Top Soil, FILL
 Asd : Dune Sand
 As : Alluvial Sand
 Ac : Alluvial Clay
 Ap : Alluvial Peat
 Estimated Liquefied Layer

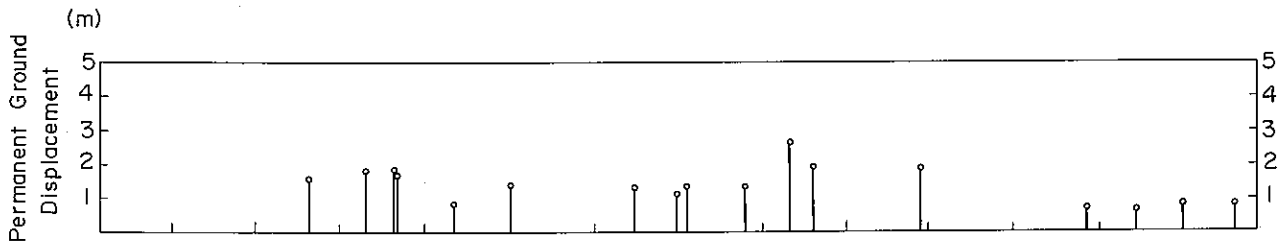
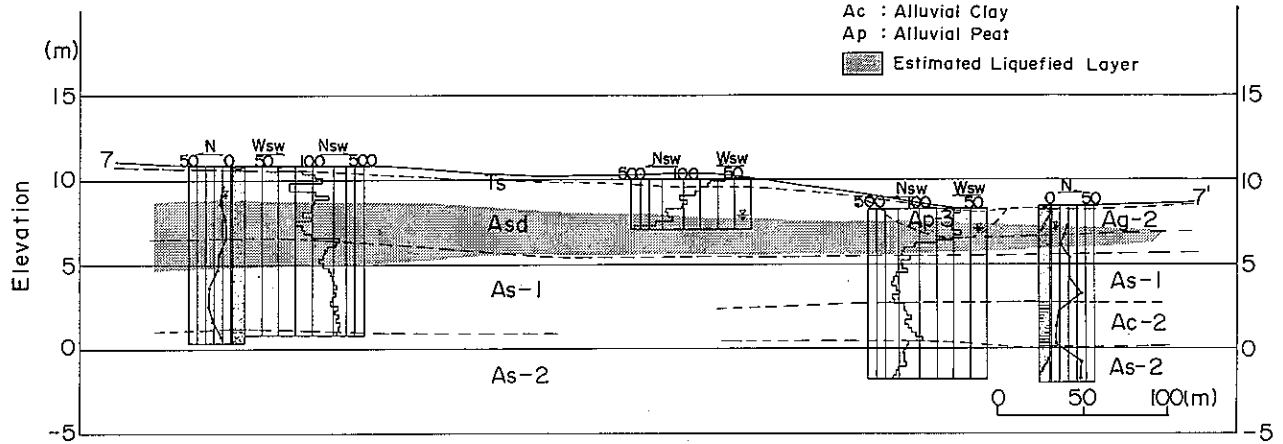

(26) Section N-7

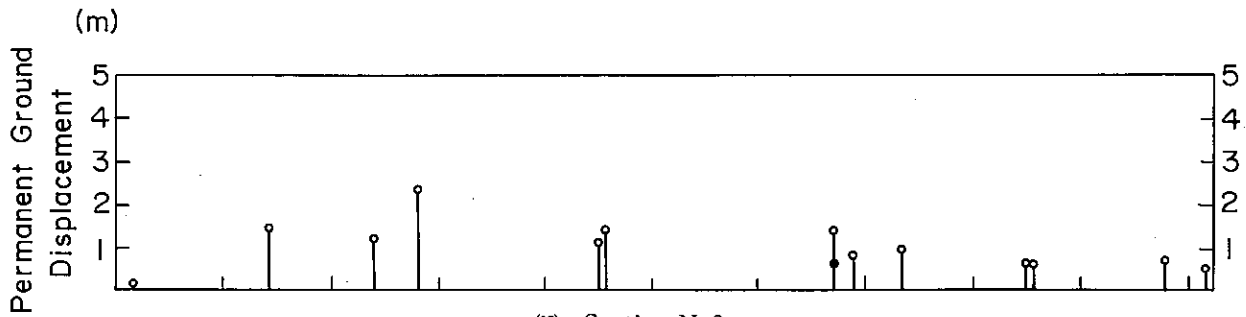
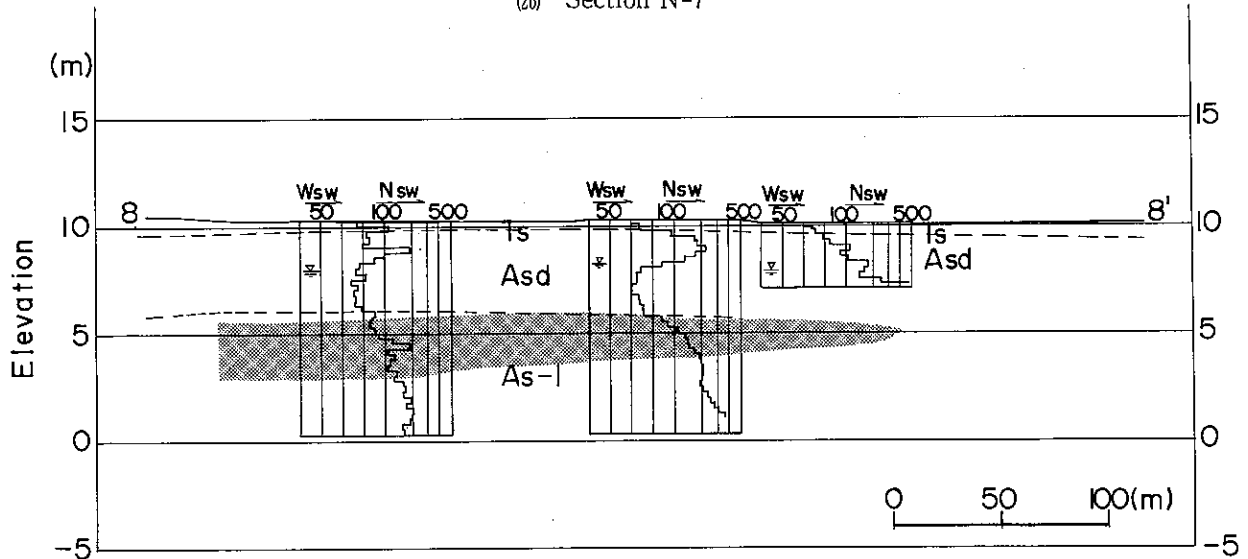

(27) Section N-8

Fig. V-1 Soil layer profile in Noshiro City